



Mid-States Concrete Industries

total precast CROSS SECTION & STRAND CONFIGURATIONS

12"X48" HOLLOWCORE

CROSS SECTION

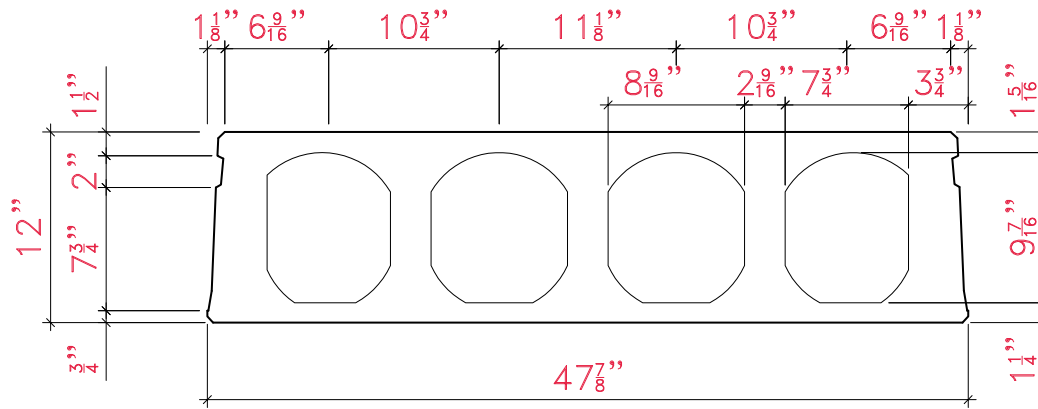

NOTES:

STRAND CONFIGURATIONS

FOR INFORMATIONAL PURPOSES ONLY

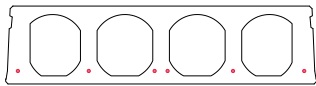

1.75-68

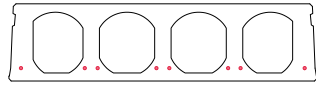

1.75-88
1.75-28+610

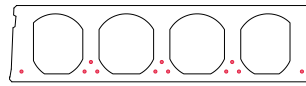

1.75-28+910



1.75-68+TC27
1.75-68+TP27
1.75-68+TP28

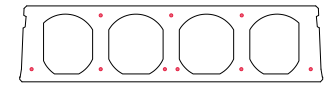

1.75-68+TP37

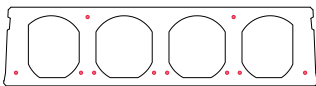

1.75-88+TC27
1.75-88+TP27
1.75-28+610TC27
1.75-28+610TP27
1.75-28+610TP28

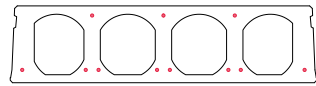

1.75-88+TC37
1.75-88+TP37
1.75-28+610TP37

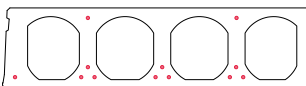

1.75-28+910TC27
1.75-28+910TP27
1.75-28+910TP28

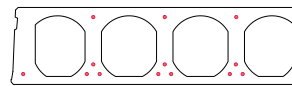

1.75-28+910TP37
1.75-28+910TP38



Mid-States Concrete Industries, 500 South Park Ave., South Beloit, IL 61080

P/ 800.236.1072 P/ 815.389.2277 P/ 608.364.1072 | F/ 815.389.2339

E/ info@msprecast.com | W/ www.msprecast.com



Expand your Freedom > Experience our Commitment
Mid-States Concrete Industries